

Owner's Manual

Interactive Touchscreen Display

Model: DMTP55N0

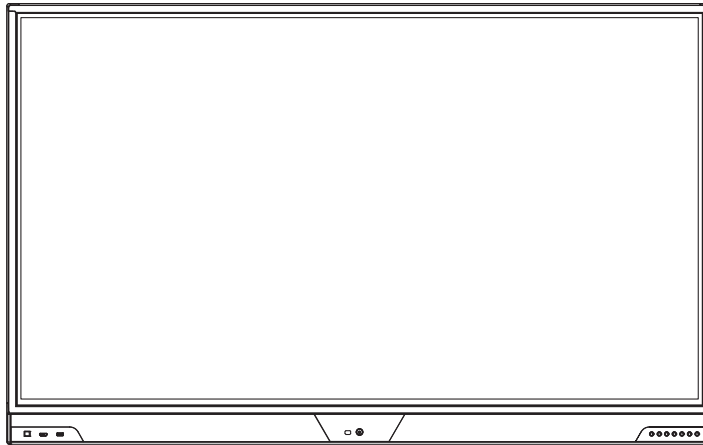

1. Important Safety Instructions	2
2. Preparation	4
3. Features	6
4. Initial Setup	10
5. Touch Operation	11
6. Troubleshooting	22
7. Specifications	22
Warranty & Product Registration	24
Regulatory Compliance	24

WARRANTY REGISTRATION

Register your product today and be automatically entered to win an ISOBAR® surge protector in our monthly drawing!

tripplite.com/warranty



1111 W. 35th Street, Chicago, IL 60609 USA • tripplite.com/support

© 2020 Tripp Lite. All rights reserved.

1. Important Safety Instructions



SAVE THESE INSTRUCTIONS

This manual contains instructions and warnings that should be followed during the operation of this product. Failure to heed these warnings may cause product damage, accident, fire, electric shock, serious injury or death. The warranty may also be affected.

1.1 Installation Warnings

- Install the product indoors, away from excess moisture or heat, conductive contaminants, dust or direct sunlight.
- Do not install the product near flammable or flame-producing objects, radiators, hot-air vents, stoves or other heat sources.
- Do not use extension cords to connect the product to an AC outlet.
- Connect the AC input power cord directly to a properly grounded 120V AC power outlet. Do not overload the outlet.
- Do not place or mount the product on any unstable or uneven surface, including any surface that isn't level.
- Do not block any ventilation openings.
- To reduce the risk of fire or electric shock, do not expose the product to rain or moisture.
- Do not place objects on or hang objects from the unit.
- Leave at least 4 inches (10 cm) of open space around the display for proper ventilation to reduce the risk of product damage or fire.
- Place the product in the installation location before removing it from its shipping container. At least four people are required to move the product safely without mechanical assistance. Observe proper lifting form to reduce the risk of injury. If a mechanical assistance device is used to move the product, ensure that the outer carton is not pierced.
- When positioning the product, hold it by the handles behind the display and by the bottom edge (but not the bottom corners). Keep the product horizontal and upright. Handle it gently and do not drop it.
- To prevent injury and product damage, securely mount the product in accordance with the accompanying mobile floor stand installation instructions (if applicable). Use only with an approved replacement specified by the manufacturer.
- Use caution when moving the product with the mobile floor stand (if applicable) to avoid injury or hardware damage.
- To mount the product to the wall, use a Tripp Lite VESA-compatible display mount, such as model DWMSC3780MUL. The wall must be solid, sturdy, stable, smooth and completely vertical. Confirm that the display mount, anchors and wall are able to bear the full weight of the product before mounting.
- Always use an assistant or mechanical lifting equipment to safely lift and position equipment.
- Do not allow any object to impact or fall into the product.
- Do not press against or stress the front panel of the product.
- Avoid dust, chemicals, oils, high humidity and other harsh environmental contaminants and conditions.
- Do not place the product in an application where it will be required to operate continuously without first consulting the manufacturer.
- Keep all packing materials and small objects out of the reach of children.
- Do not allow children to climb or play on the product, nor any furniture, stands or mounts connected to the product.
- For best performance, keep the indoor temperature between 32° F and 104° F (0° C and 40° C).
- Do not expose the product to direct air conditioning.

1.2 Connection Warnings

- Use only the AC input power cord supplied with the product, or an approved replacement specified by the manufacturer.
- Confirm that the AC input power cord is securely connected to the product's power inlet.
- Do not modify the plug, and do not use an adapter that would eliminate the ground connection.
- Do not bend the AC input power cord excessively, nor place heavy objects on the power cord. This may damage the cord.
- Do not unplug the AC input power cord from the display while the product is operating.
- Unplug the product during lightning storms or when it will be unused for long periods of time.
- When unplugging the AC input power cord, firmly grasp the plug, not the cord. Pulling on the cord may damage it.
- Do not attempt to use a damaged power cord, plug or outlet. This may cause an electric shock or fire.

1. Important Safety Instructions



- If the power cord is damaged or feels hot, turn off the main power switch, allow the cord to cool and then unplug it.
- Ensure that all cords connected to the product are properly routed and secured to prevent tripping and entanglement hazards.

1.3 Operation Warnings

- If the screen does not display an image after being turned on, unplug the AC input power cord and contact Tripp Lite for service.
- If the product is dropped or damaged, unplug the AC input power cord and contact Tripp Lite for service.
- Do not touch the product with wet hands.
- Do not touch, push, rub or tap the screen surface with your fingernail or any object other than a fingertip or the included touchscreen pen/stylus. Using a fingernail or other sharp object may damage the screen.
- Before cleaning the product, unplug the power cord. Wipe gently with a soft, dry cloth to prevent scratching.
- Do not use any chemicals, such as waxes, benzene, alcohol, glass cleaners, thinners, insecticides, air fresheners or lubricants on the product, as these may damage the screen's finish and cause discoloration.
- Do not spray water or other liquids directly on or into the product. If liquid enters the product, it may result in fire, electric shock, hardware damage or malfunction. Unplug the AC input power cord immediately.
- If a fixed image displays on the screen for a long period of time, it may become imprinted on the screen permanently. This image burn-in is not covered by the product warranty. Avoid displaying fixed images for excessive periods (2+ hours), turn off the screen when not in use and use the built-in screen saver to prevent image burn-in.
- When viewing the screen, take 5- to 15-minute breaks every hour. Viewing the screen for long periods without rest may cause fatigue and eyestrain.
- Do not touch the ventilation openings. They may become hot when the product is in operation.
- If the product emits smoke or a burning smell, unplug the AC input power cord and contact Tripp Lite for service.

1.4 Remote Control Battery Warnings

- Use only the size and type of batteries specified.
- Follow the correct polarity when installing the batteries, as indicated in the battery compartment. Reversed batteries may damage the remote control.
- Do not mix different battery types (e.g. Alkaline, Carbon-zinc or Rechargeable) or old and new batteries.
- If the remote control will not be used for a long period of time, remove the batteries to prevent damage or injury from possible battery leakage.
- Do not try to recharge batteries that are not designed to be recharged; they may overheat and rupture.
- Use caution when inserting batteries to avoid battery damage and potential short circuits. Never use damaged batteries, as they may overheat and cause device damage or injury.
- Do not expose batteries to excessive heat such as direct sunlight or fire.

1.5 Service Warnings

- There are no user-serviceable parts inside the display. To reduce the risk of electric shock, do not attempt to open or remove any part of the display's enclosure for any reason, including the back cover. There are dangerous voltages inside the product.
- If service is required, contact Tripp Lite at 773.869.1234 or triplite.com/support. Service performed by non-authorized personnel will void the product warranty.

2. Preparation

2.1 Unpacking

- 1 Set the shipping carton in an upright position.
- 2 Cut the plastic banding from the carton, taking care not to damage the contents.
- 3 Remove the retention clips from the outer carton.
- 4 Lift off the top of the carton and remove the top corner protectors.
- 5 Remove the inner accessories kit.
- 6 Remove the inner plastic bag covering the display.

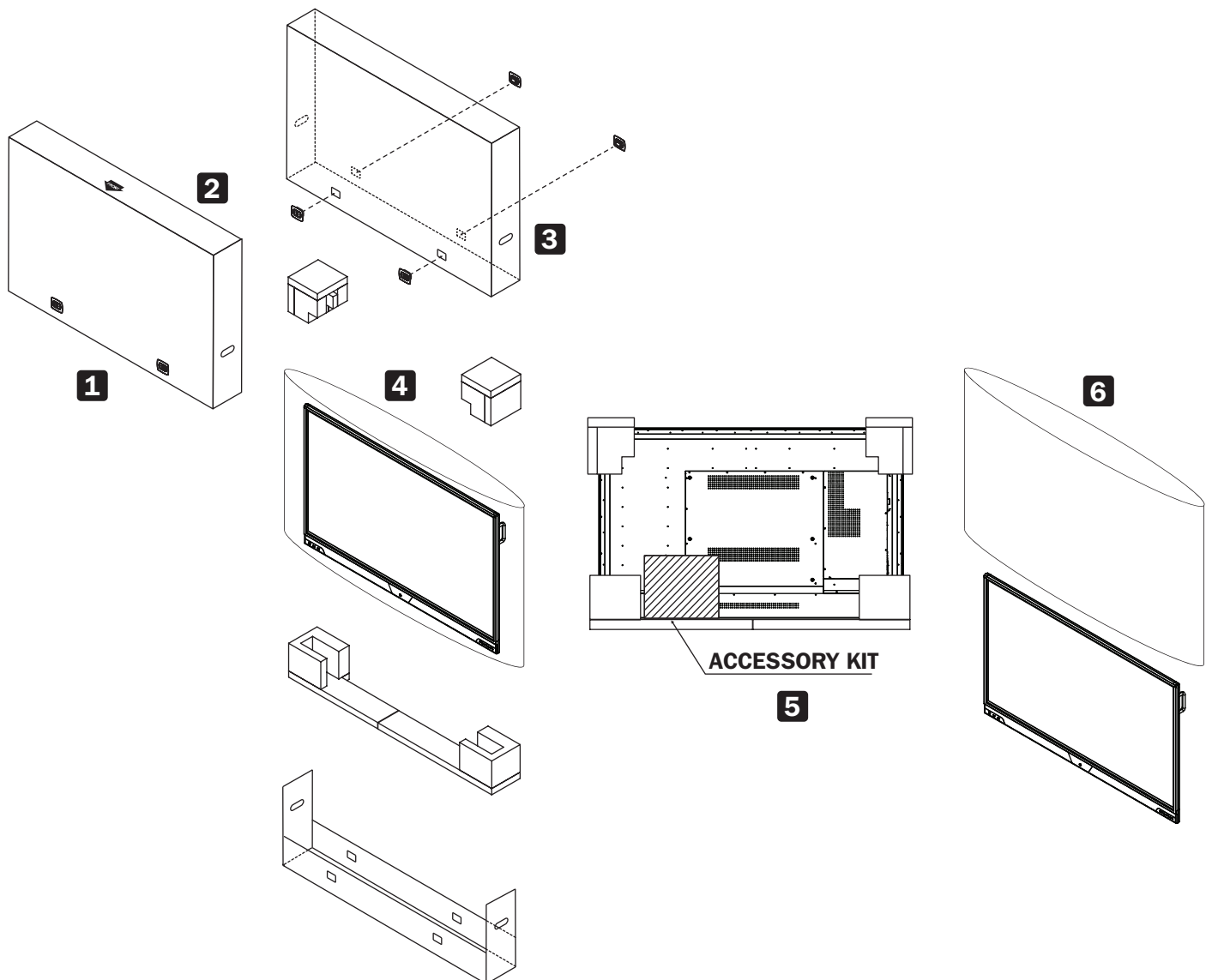

2. Preparation

IMPORTANT: Confirm you have received all components prior to installation. Inspect each component. If anything is missing or appears to be damaged, contact Tripp Lite.

2.2 Components Checklist

- 1** Touchscreen Display
- 2** USB Touch Cable
- 3** HDMI Cable
- 4** AC Input Power Cord
- 5** HD Webcam
- 6** Remote Control
- 7** AAA Batteries (2)
- 8** Wi-Fi Antennas (4)
- 9** Touchscreen Stylus Pens with Replacement Tips (2)

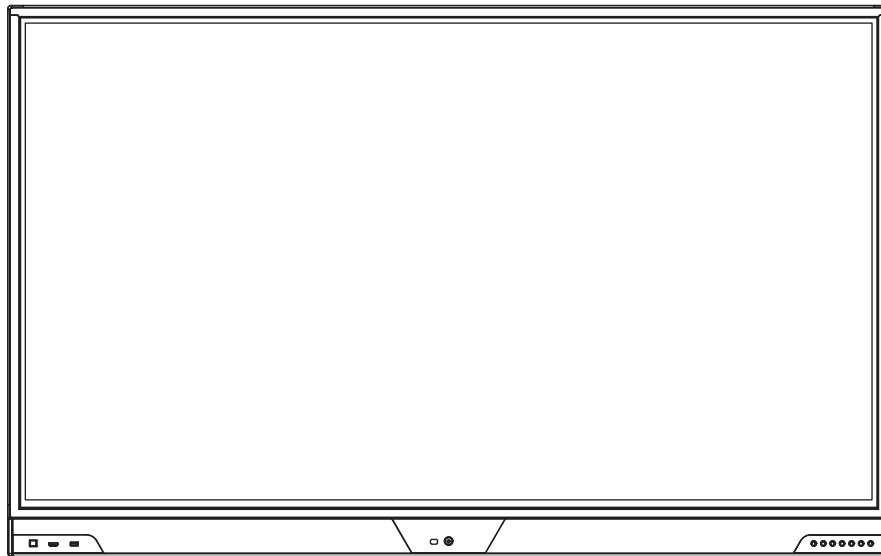

1

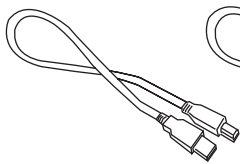

2

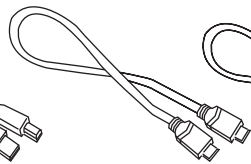

3

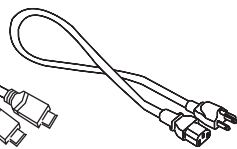

4

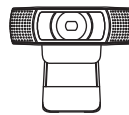

5



6



7

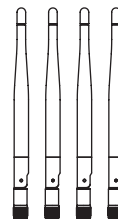

8



9

3. Features

3.1 Front Panel

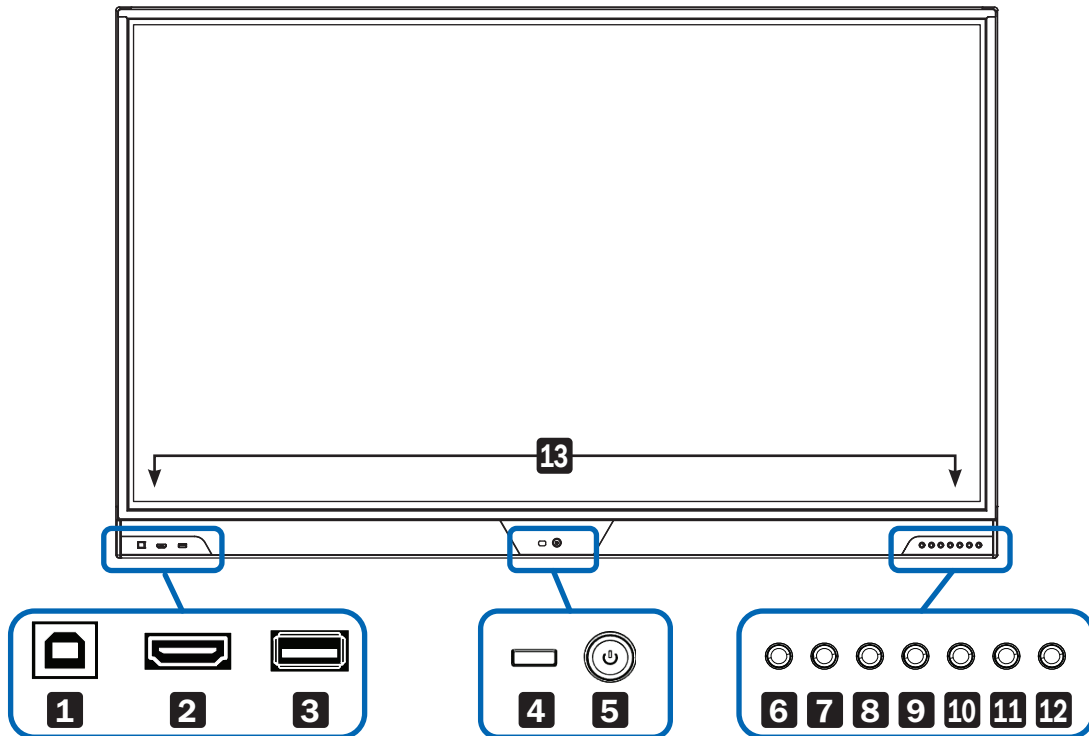

1 USB Touch Port

Note: If you decide to use a front or rear USB touch port, use the included USB cable or a user-supplied USB 2.0 A-B cable that is 3 m or shorter to ensure signal integrity.

2 HDMI Port

3 USB 2.0 Port

4 IR Receiver for Included Remote Control

5 Power Button with Status LED (On: Blue / Standby: Red)

6 Source Button

7 Menu Button

8 Volume - Button

9 Volume + Button

10 ◀ (Left) Arrow Button

11 ▶ (Right) Arrow Button

12 Touch On/Off Button

13 Built-in Soundbar Speakers with Subwoofer

3. Features

3.2 Rear Panel

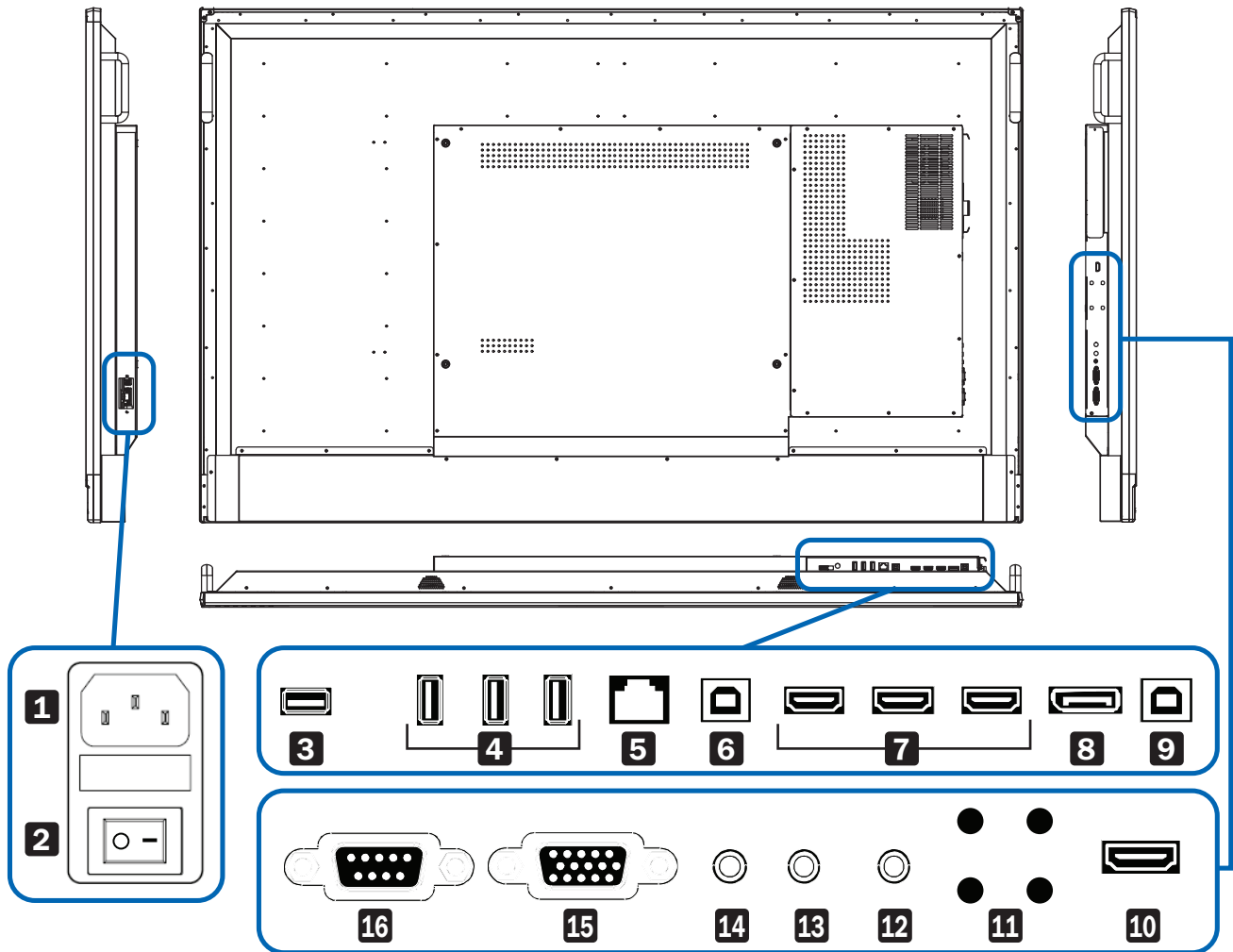

1 AC Inlet
(C14, 100-240V, 50/60 Hz)

2 Master On/Off Switch
(O: Off; —: On)

3 Camera Input (Common USB)

4 USB 2.0 Ports (3 – Android Only)

5 LAN Port (RJ45 Ethernet)

6 USB Touch Port (For HDMI)

7 HDMI Input (3)

8 DisplayPort Input

9 USB Touch Port (For DP/VGA)

10 HDMI Output

11 Wi-Fi Antenna Connectors (4)

12 3.5 mm Audio Output
(Headphone)

13 3.5 mm Audio Input (Microphone)

14 3.5 mm Audio Input (VGA)

15 VGA Video Input (HD15)

16 RS-232 Serial Port (DB9)

3. Features

3.3 VESA Mounting Pattern

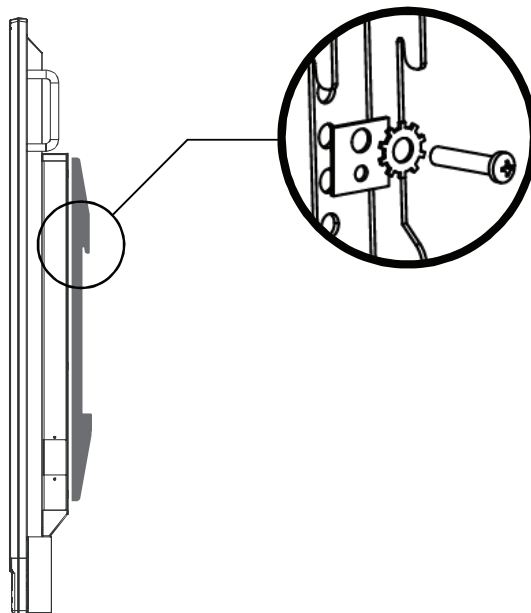
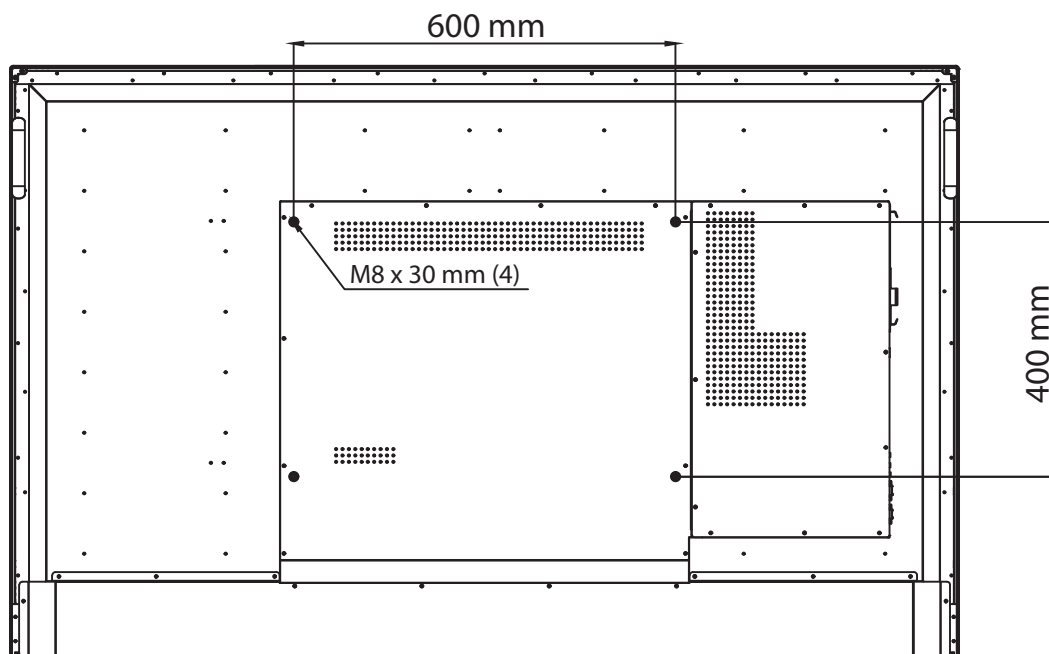

3. Features

3.4 Remote Control Layout

You can control the touchscreen display in several ways:

1. Using the remote control.
2. Using the physical buttons on the display.
3. Using the on-screen display menus and touch input.



Button	Description
	Power (On/Standby)
	Mute
	Input Selection Menu
FREEZE	Freeze Screen Image
HDMI	Select HDMI Input Front HDMI HDMI1 HDMI2 HDMI3 ↻
DP	Select DisplayPort Input
ECO	Adjust Screen Brightness (3 Levels)
OPS	OPS (Built-in PC) Selection/Startup (Not Available On This Version)
VGA	Select VGA Input
DICOM	DICOM (Digital Imaging and Communications in Medicine) Calibration On/Off
MIRROR	Wireless Screen Mirroring with EShare
EYE	Eye Protection On/Off (Reduces Screen Brightness During Touch Operations)
MENU	Activate Main OSD Menu
EXIT	Close Main OSD Menu
INFO	Show Current External Input
	Menu Navigation/Adjustment
OK	Menu Selection
PSM	Picture Status Memory (Preferred Picture Setting)
SSM	Sound Status Memory (Preferred Sound Setting)
VOL +	Volume Up
VOL -	Volume Down
	Previous Chapter
	Play/Pause
	Stop
	Next Chapter
	Activate Floating Menu
	Activate Home Screen
	Touch On/Off

4. Initial Setup

4.1 Mounting

After unpacking the unit and assembling the optional mobile stand (sold separately), mount the unit according to the mobile stand instructions.

4.2 Wi-Fi Antenna Connection

After mounting the unit securely to a mobile stand or wall mount, connect the included Wi-Fi antennas to the rear of the unit.

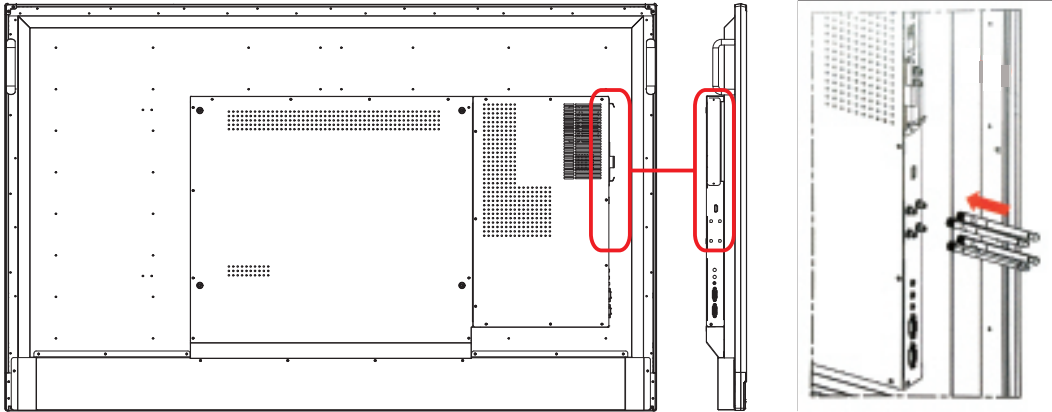

4.3 Camera Connection

Clip the included HD webcam to the top of the display. You can reposition it as needed. Using the included USB cable, connect the webcam to the camera input at the rear of the unit.

4.4 Remote Control Setup

Insert the included AAA batteries into the included remote control. Follow the polarity (+/-) indicated in the battery compartment.

4.5 Power Connection

Connect one end of the included AC input power cord to the unit's C14 inlet. Connect the plug to a grounded 120V AC outlet on the optional battery system. If you are not using the battery system, connect the plug directly to a properly grounded 120V 15A AC wall outlet. The master on/off switch next to the C14 inlet must be in the "on" position for the unit to function. Set the master on/off switch to the "off" position if the unit will be idle for more than a few days.

4.6 Initial Display (Android) Startup

Press the power button on the front of the unit or the remote control. After a brief startup sequence, the unit will be ready to use. Select "menu" and enter the wireless network settings for your location. If you are unsure how to do this, contact your IT department for the correct network settings.

4.7 Touch Input

Only use the included touch pens or fingertips on the screen surface. If you need additional touch pens, inexpensive replacements are available from Tripp Lite.

4.8 Shutdown

Press the power button on the remote to shut down the display. If you intend to turn off the master on/off switch, wait until the display has shut down completely.

5. Touch Operation

IMPORTANT: Only use the included touch pens or fingertips on the touchscreen surface. If you need additional touch pens, inexpensive replacements are available from Tripp Lite.

5.1 Home Screen

After startup, you will see the time, date and three buttons on the home screen:

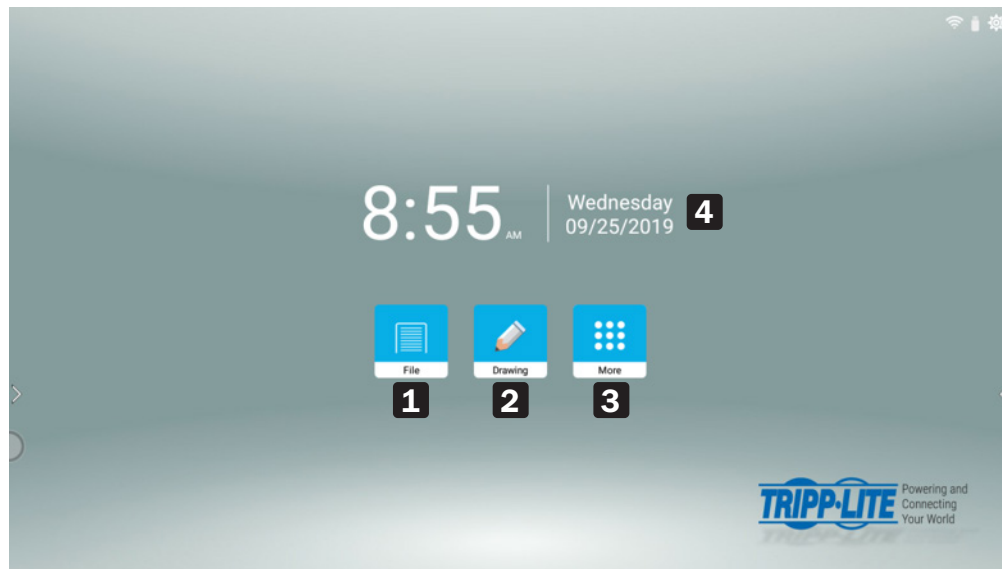

- 1** File Manager
- 2** Drawing Application (Whiteboard)
- 3** More Applications
- 4** Date and Time

5.1.1 File Manager

Open, move, copy, create or delete folders and files.

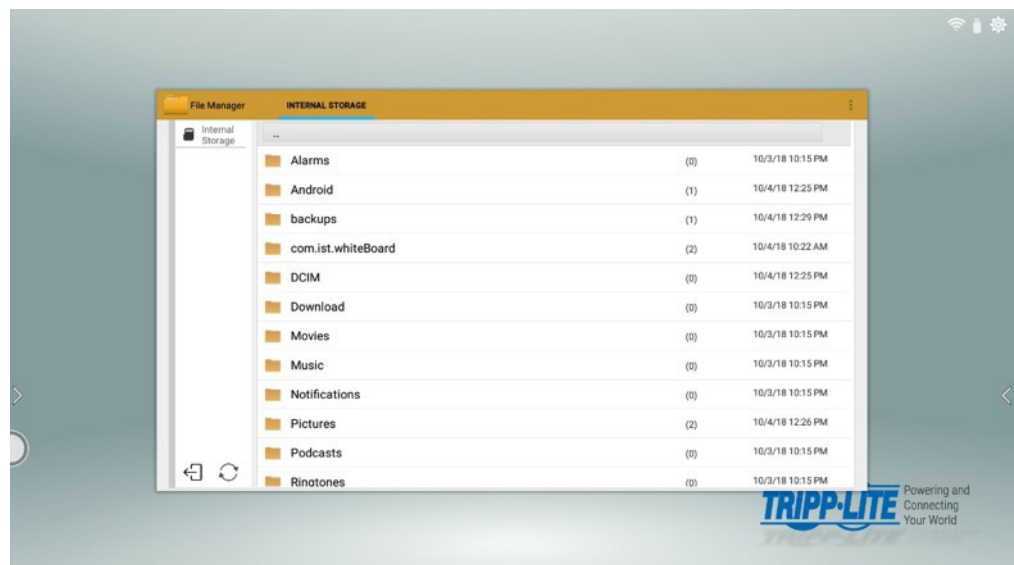







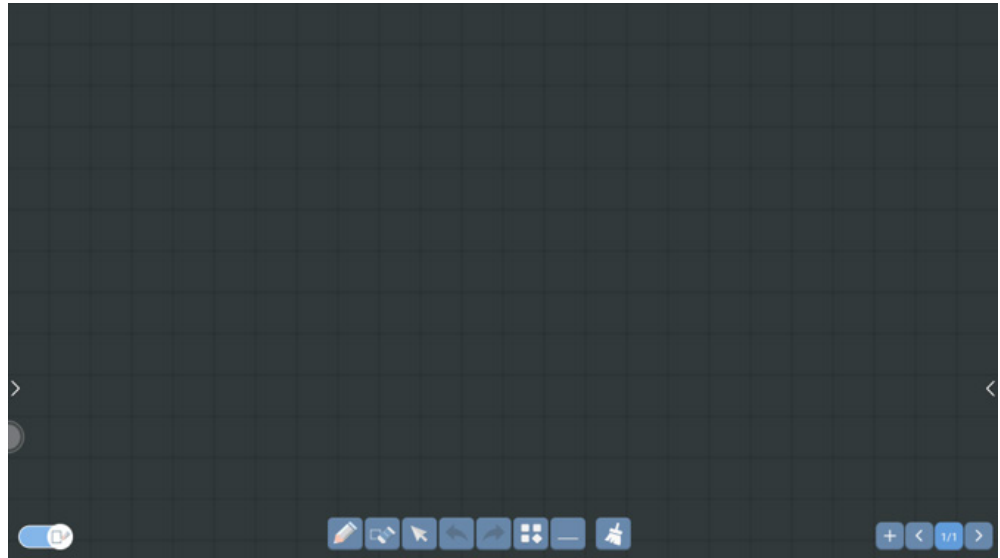





5. Touch Operation

5.1.2 Drawing Application (Whiteboard)

Open the built-in whiteboard application for drawing or writing on the screen.







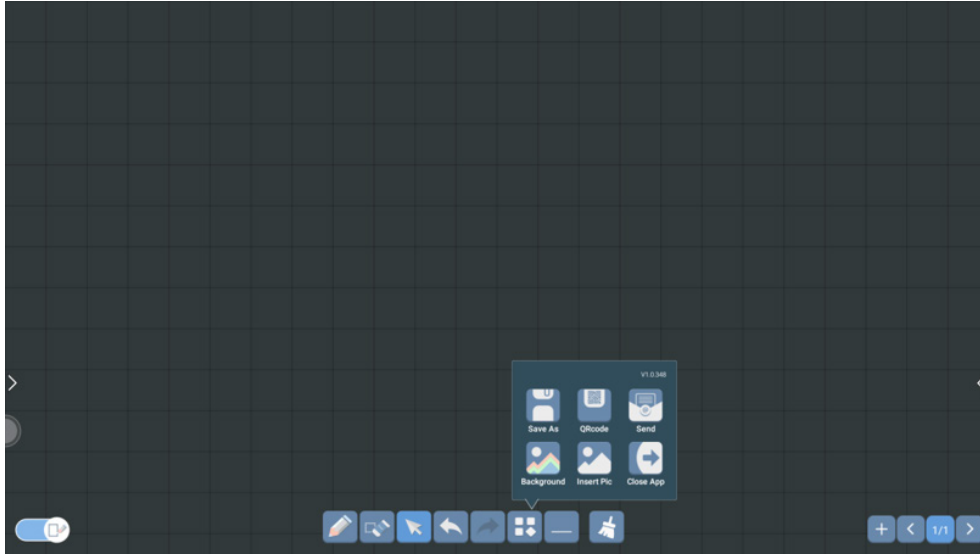

Button	Description
	Menu: Provides extra options.
	Pen: Customize line weight, transparency and color.
	Erase: Clear the entire page or choose a precise eraser.
	Minimize: Hide the drawing screen.
	Pointer: Select content.
	Undo: Undo the most recent action.
	Redo: Redo the most recent action.
	Sweep: Clear all drawing.
	Add: Add saved images.
	Previous: Move to the previous drawing page.
	Next: Move to the next drawing page.
	Counter: Current page / total pages.
	Background On/Off: Shows most recent screen behind drawing when off.

5. Touch Operation

5.1.2.1 Drawing Application Menu Options



Button	Description
	Save As: Save the content on the page as PNG or PDF. (You can customize the save path.)
	QR Code: Send the page content to a device on the same network through the QR code.
	Send: Save the content on the page and send as an email.
	Background: Set the background pattern and color.
	Insert Pic: Insert a picture that is saved on the device.
	Close App: Exit the drawing application.

QR Code



5. Touch Operation

5.1.2.2 Drawing Application Pen Overview

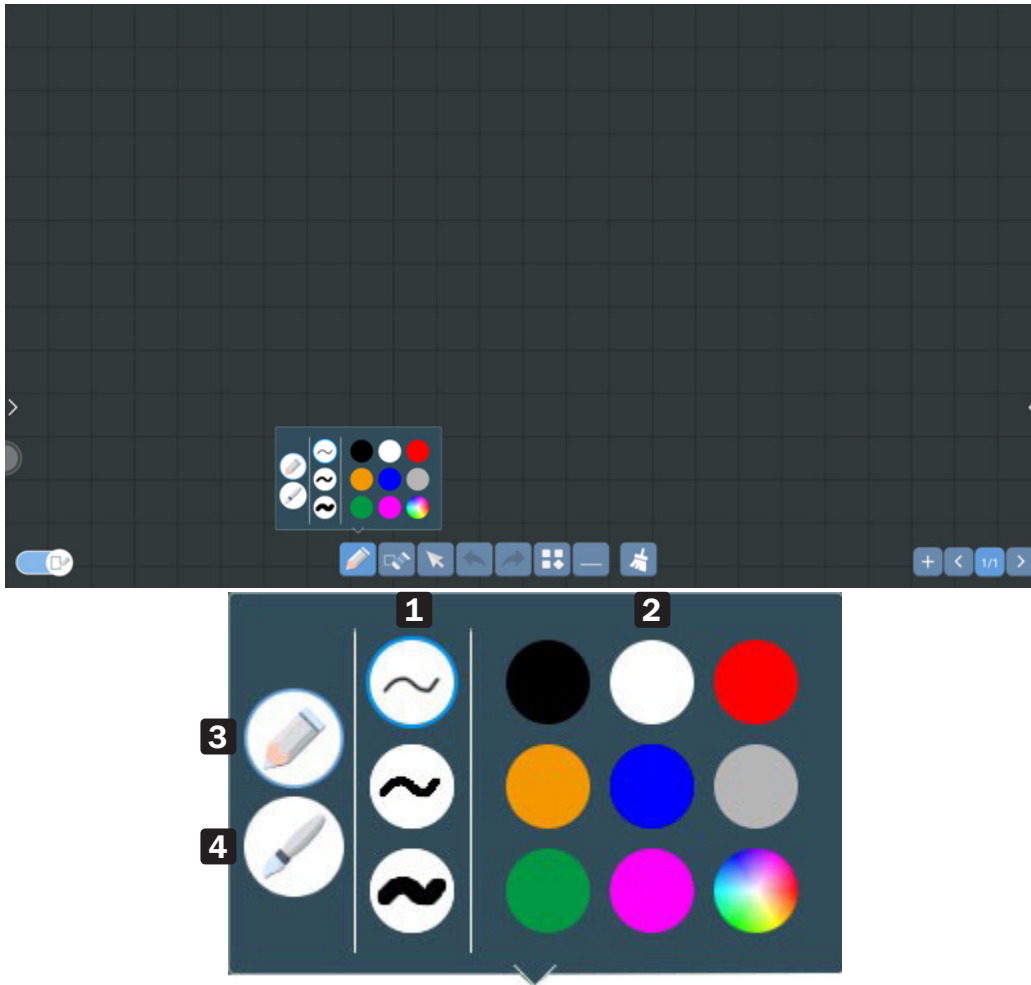



Option	Description
1 Line Weight	Choose the thickness of the line left by the pen.
2 Color	Choose one of the preset colors or a custom color.
3 Standard Pen	Use the pen with the preset line weight and color.
4 Brush Pen	Identify the contact area to change the line thickness.

5. Touch Operation

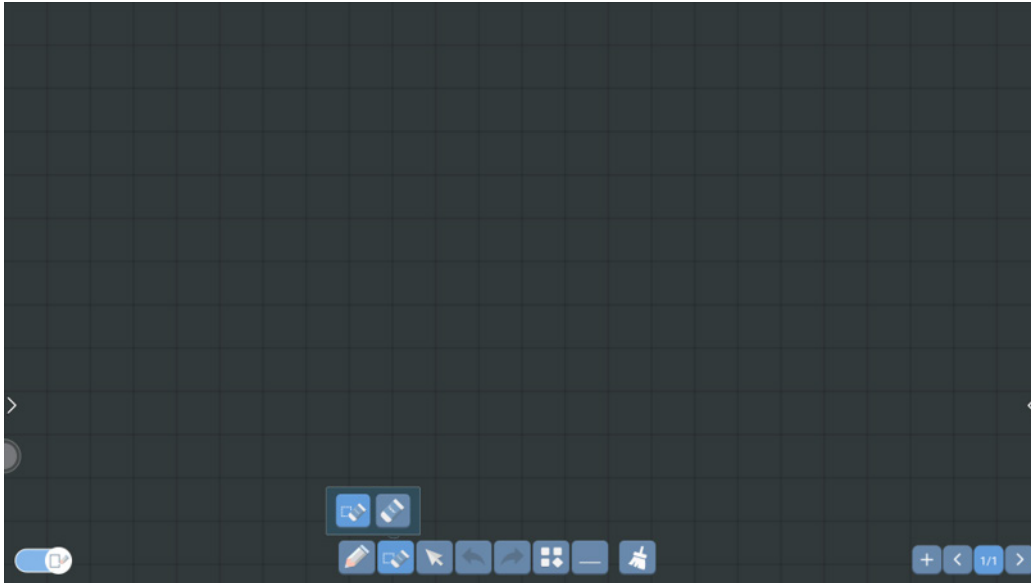
5.1.2.3 Drawing Application Eraser Overview



Option	Description
	Object Eraser: Selects and erases an entire object, such as a line.
	Standard Eraser: Erases only the pixels you touch.

5.1.2.4 Multitouch Gestures

The display supports from 1 to 20 points of multitouch. That means it can detect and process up to 20 simultaneous touch inputs.



Move two fingers apart to zoom in; move two fingers together to zoom out. These gestures can also adjust the size of an object.



Drag several fingers to activate the eraser block and erase on-screen drawing.



5. Touch Operation

5.1.3 More Applications

Access additional Android-based applications, including a web browser, media player, system settings, camera and helper. The drawing and file manager functions from the previous screen are also available in this section.

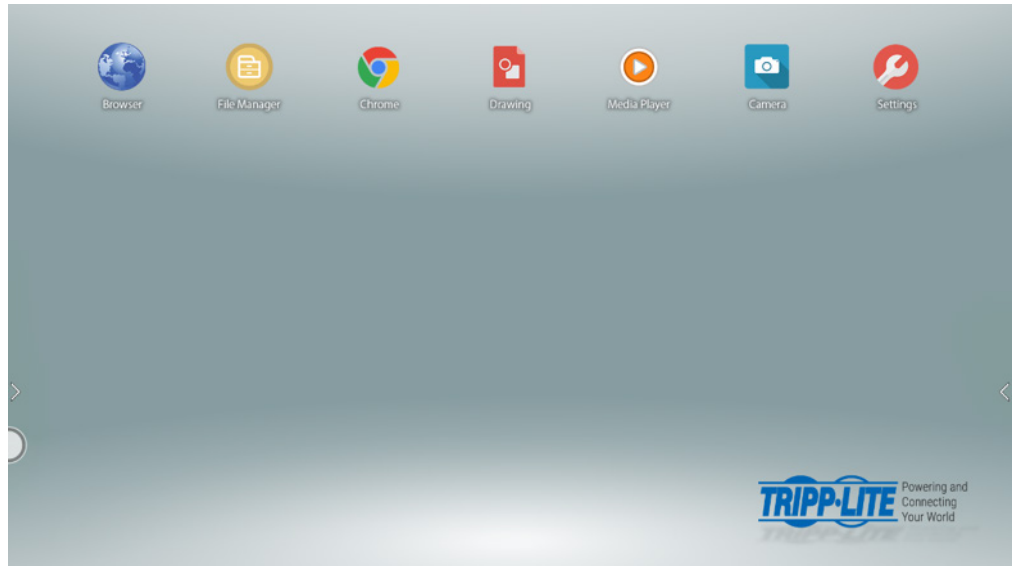
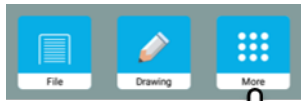

5. Touch Operation

5.2 Navigation Bar

Access the navigation bar by sweeping up from bottom of the screen (for a bottom bar) or by touching one of the arrows on either side (for a side bar).

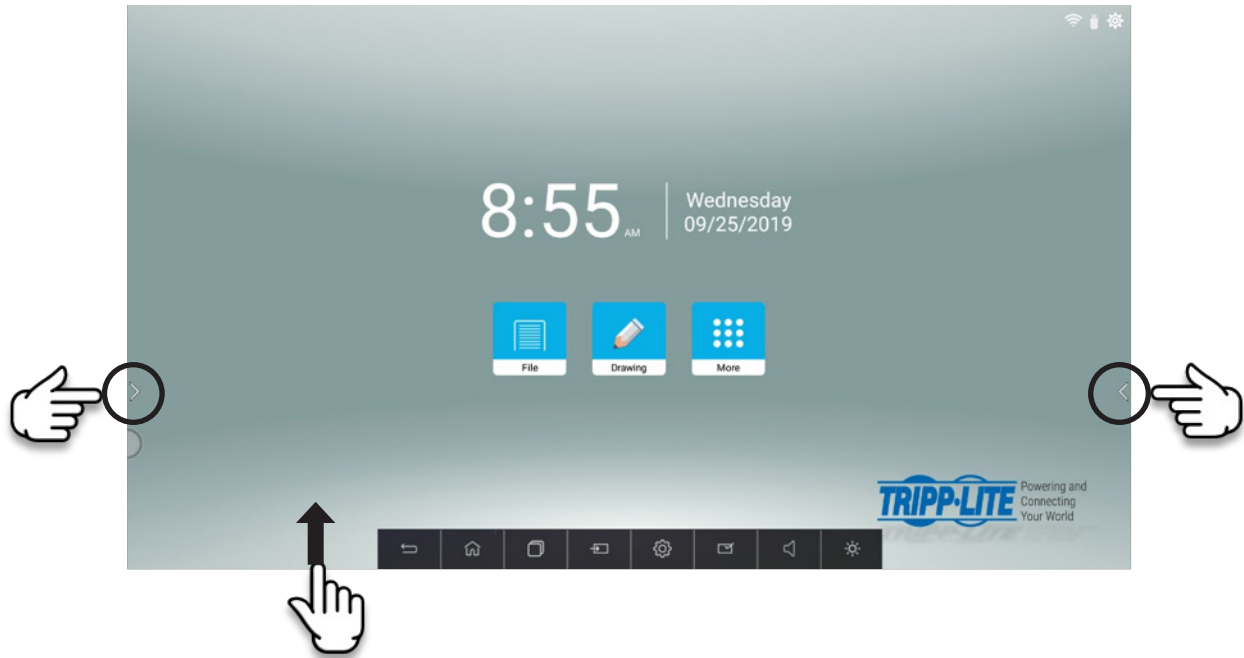

5.2.1 Navigation Bar Overview

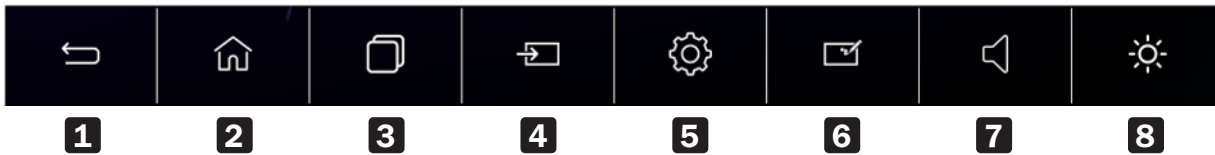





Button	Description
1 Backward	Move back to the previous step.
2 Home	Go to the home screen.
3 Manage	Switch and clear the program.
4 Source	Activate the external input window.
5 Settings	Show the system settings interface.
6 Whiteboard	Write on the system interface.
7 Volume	Adjust the speaker volume.
8 Brightness	Adjust the screen brightness.

5. Touch Operation

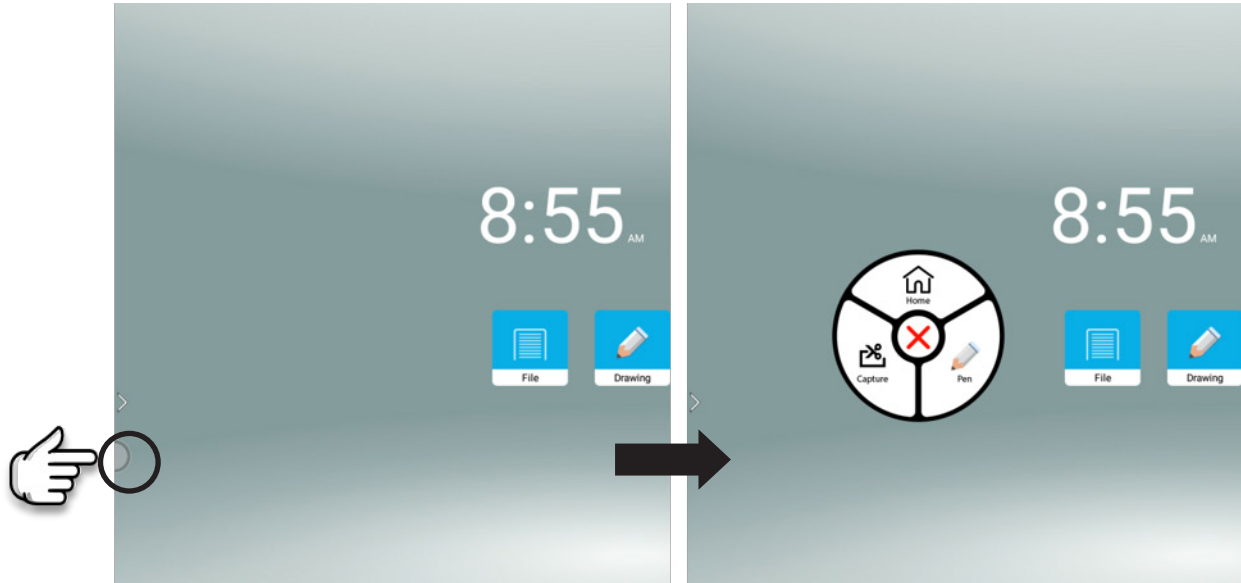
5.3 Floating Annotation Menu

Touch the semicircle at the left edge of the screen to activate the floating annotation menu.



Button	Description
 Home	Home: Return to main interface.
 Capture	Screen Capture: Save .bmp file of current screen.
 Pen	Pen: Switch to pen menu.
	Exit: Close floating annotation menu.

5. Touch Operation

5.4 External Source Selection



- 1** Touch the Source button on the navigation bar to activate the external source selection menu.
- 2** Input connections with an active external source device connected are indicated by a green dot. Select an external source by touching the corresponding row in the menu.
- 3** Touch the pencil icon to change the external source labels.

5. Touch Operation

5.5 Settings (Android)

Swipe up from the bottom of the screen to access the pop-up settings interface from the Navigation Bar.

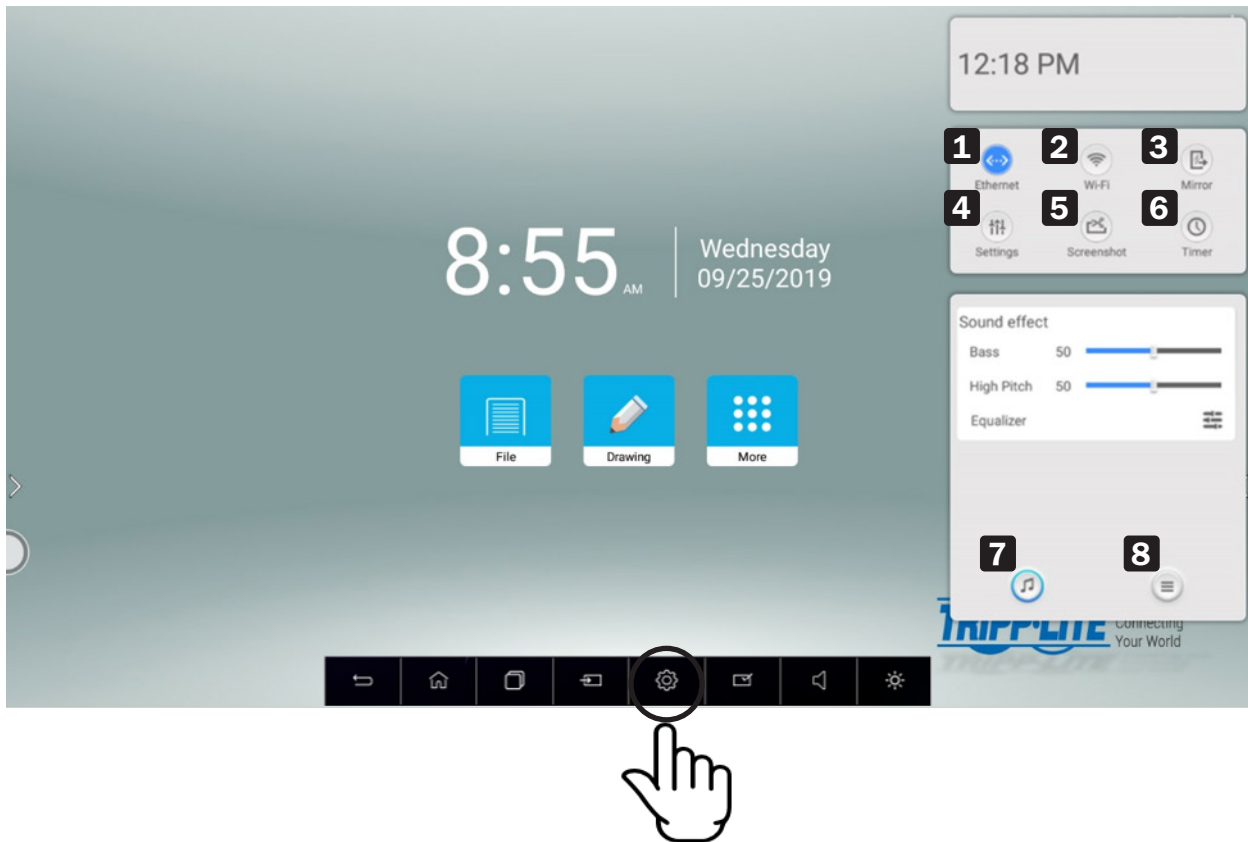

Button	Description
1 Ethernet	Local area network settings.
2 Wi-Fi	Wireless network settings.
3 Mirror	Screen mirroring with EShare.
4 Settings	Access the settings menu – see Section 5.5.1 for more information.
5 Screenshot	Save a screenshot of the current screen.
6 Timer	Set a countdown timer.
7 Sound	Set audio and equalizer levels.
8 More	Set no signal standby delay, source identification and eye protection on/off.

(Eye protection reduces screen brightness during touch operations to help prevent eyestrain.)

5. Touch Operation

5.5.1 Settings Menu

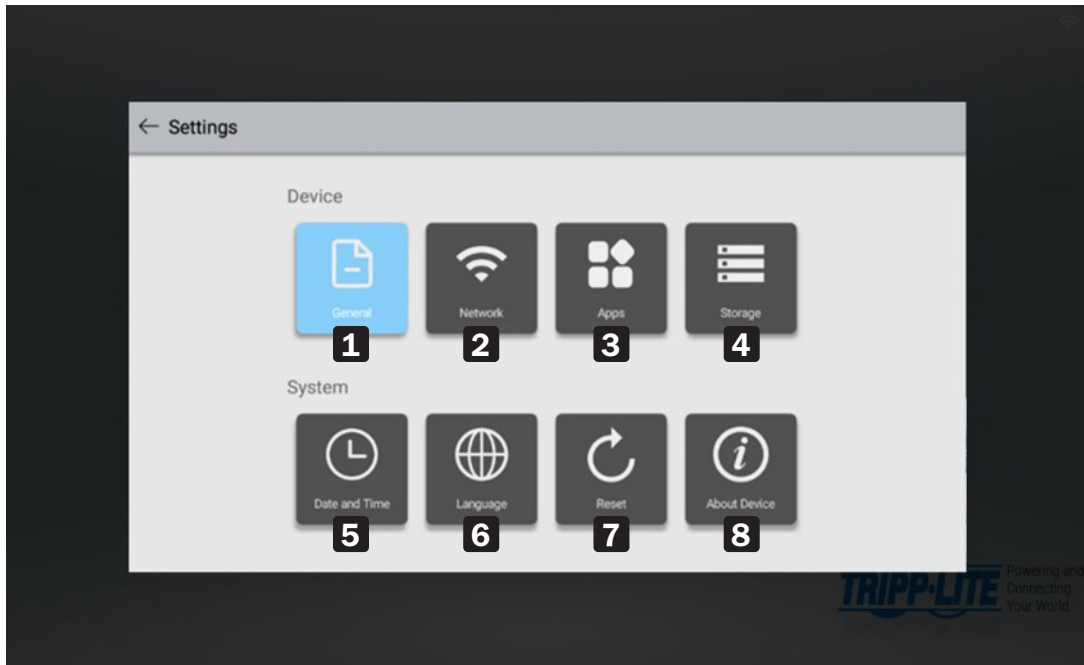

Note: This menu is also accessible from the More Applications screen shown in **Section 5.1.3**.

Button	Description
1 General	Volume level, eye protection on/off, DICOM calibration on/off, sidebar on/off, startup, shutdown, screen lock, wake on LAN, HDMI output format, wallpaper.
2 Network	Wi-Fi, WLAN hotspot, Ethernet LAN, file sharing, Bluetooth, proxy settings.
3 Apps	Settings for installed Android applications.
4 Storage	View Android storage space used and remaining by category.
5 Date and Time	Set time, date, time zone and network synchronization.
6 Language	Set language and input methods.
7 Reset	Return the system to factory settings, permanently erasing any other data.
8 About Device	View information about the hardware and operating system.

6. Troubleshooting

Before contacting Tripp Lite, try the common solutions listed below.

Problem	Possible Solution
No display. Power LED off.	<ol style="list-style-type: none"> 1. Make sure the AC input power cord is connected firmly at both ends. 2. Make sure the master on/off switch by the power inlet is set to the on position.
No display. Power LED on or blinking.	<ol style="list-style-type: none"> 1. Make sure the selected input source is active and the cable is connected to the correct port at both ends. 2. Try pressing a key on the remote to wake the display. 3. Try turning the product off and on again.
Remote control doesn't function.	<ol style="list-style-type: none"> 1. Make sure to aim the remote at the IR sensor near the power button on the front of the display. 2. Make sure the batteries do not need to be replaced. The batteries should last 6 to 12 months under typical conditions. 3. Make sure the batteries are installed with correct polarity (+/-), as shown in the battery compartment.
Any other problem.	Contact Tripp Lite support.

7. Specifications

LED Display	
Diagonal Size	54.64 in. (1387.8 mm)
Aspect Ratio	16:9
Pixel Format	3840 x 2160
Pixel Pitch	0.315 mm x 0.315 mm
Brightness	350cd/m ² (Typ.)
Contrast Ratio	1300:1 (Typ.)
BLU Type	D-LED Type
Color Depth	10-bit (D), 1.07 Billion Colors
Viewing Angle (CR>10)	R/L 178 (Min.), U/D 178 (Min.)
Touch Panel	
Touch Technology	IR (Ultra Slim Infrared)
Detect Area	1209.6 (H) x 6804 (V) mm
Touch Point	Max. 20 Points (Android)
Touch Tool	Hand or Other Solid Object (Pen Tip > 3.0 mm)
Response Speed	<8 ms (1 Touch)
Accuracy	±1 mm
Operation System	

7. Specifications

I/O Port	
Front (Input)	HDMI x 1, USB x 1, USB (For Touch) x 1
Rear (Input)	HDMI x 4 , DP x 1, VGA x 1, PC Audio-In x 1 , MIC In
	USB (Camera Input), USB x 3, USB (For Touch) x 2
Rear (Output)	HDMI Out x 1, Earphone x 1
Communication Port	RS-232 (D-Sub 9-Pin), LAN (RJ45)
Android System Specification	
System	MStar 648.2 (System Memory 2G, Storage 32G)
Android Version	6.0
OPS (Optional)	
OPS	N/A
Others	
Front Panel Button	Power On/Off
	7-Function Key for Source, Menu, Menu Up/Down, Vol. Up/Down, Touch On/Off
OSD Control Function	RS-232C, IR Remote Controller
Speaker Output	20W x 2, With Woofer
Safety Standard	CB, CE, FCC, NRTL, KC, RoHS
Power Supply	AC 100-240V, 50/60 Hz
	Power Consumption ≤200W
Operating Temperature	0 ~ 40°C, 20% to 80% RH (No Condensation)
Storage Temperature	-4 ~ 140°F (-20 ~ 60°C)
Dimensions (W x H x D)	50.4 x 32.3 x 3.6 in. [±0.2 in.] (1280 x 820 x 91 mm [± 5 mm])
VESA Mount	400 x 300 (mm), M8 Screw
Net Weight	77.2 lb. (35 kg)
Gross Weight	94.8 lb. (43 kg)

Warranty & Product Registration

2-Year Limited Warranty

Seller warrants this product, if used in accordance with all applicable instructions, to be free from original defects in material and workmanship for a period of 2 years from the date of initial purchase. If the product should prove defective in material or workmanship within that period, Seller will repair or replace the product, in its sole discretion.

THIS WARRANTY DOES NOT APPLY TO NORMAL WEAR OR TO DAMAGE RESULTING FROM ACCIDENT, MISUSE, ABUSE OR NEGLIGENCE. SELLER MAKES NO EXPRESS WARRANTIES OTHER THAN THE WARRANTY EXPRESSLY SET FORTH HEREIN. EXCEPT TO THE EXTENT PROHIBITED BY APPLICABLE LAW, ALL IMPLIED WARRANTIES, INCLUDING ALL WARRANTIES OF MERCHANTABILITY OR FITNESS, ARE LIMITED IN DURATION TO THE WARRANTY PERIOD SET FORTH ABOVE; AND THIS WARRANTY EXPRESSLY EXCLUDES ALL INCIDENTAL AND CONSEQUENTIAL DAMAGES. (Some states do not allow limitations on how long an implied warranty lasts, and some states do not allow the exclusion or limitation of incidental or consequential damages, so the above limitations or exclusions may not apply to you. This warranty gives you specific legal rights, and you may have other rights which vary from jurisdiction to jurisdiction).

WARNING: The individual user should take care to determine prior to use whether this device is suitable, adequate or safe for the use intended. Since individual applications are subject to great variation, the manufacturer makes no representation or warranty as to the suitability or fitness of these devices for any specific application.

Product Registration

Visit tripplite.com/warranty today to register your new Tripp Lite product. You'll be automatically entered into a drawing for a chance to win a FREE Tripp Lite product!*

* No purchase necessary. Void where prohibited. Some restrictions apply. See website for details.

Regulatory Compliance

Regulatory Compliance Identification Numbers: For the purpose of regulatory compliance certifications and identification, your Tripp Lite product has been assigned a unique series number. The series number can be found on the product nameplate label, along with all required approval markings and information. When requesting compliance information for this product, always refer to the series number. The series number should not be confused with the marketing name or model number of the product.

FCC Specifications for Models with FCC Class A Approval:

This device complies with part 15 of the FCC Rules. Operation is subject to the following two conditions: (1) This device may not cause harmful interference, and (2) this device must accept any interference received, including interference that may cause undesired operation.

Note: This equipment has been tested and found to comply with the limits for a Class A digital device, pursuant to part 15 of the FCC Rules. These limits are designed to provide reasonable protection against harmful interference when the equipment is operated in a commercial environment. This equipment generates, uses, and can radiate radio frequency energy and, if not installed and used in accordance with the instruction manual, may cause harmful interference to radio communications. Operation of this equipment in a residential area is likely to cause harmful interference in which case the user will be required to correct the interference at his own expense. The user must use shielded cables and connectors with this equipment. Any changes or modifications to this equipment not expressly approved by Tripp Lite could void the user's authority to operate this equipment.

Tripp Lite has a policy of continuous improvement. Specifications are subject to change without notice. Photos and illustrations may differ slightly from actual products.



1111 W. 35th Street, Chicago, IL 60609 USA • tripplite.com/support